



Gebrüder Dreher Drehteile & Gasfedern GmbH



Product Line Gas Springs

Introduction

We are an owner-run family business with a success story that began some 70 years ago with the production of high-precision turned parts. Then, 25 years ago, we expanded our product line to include gas springs. At about the same time we completed our transformation from a sub-supplier into a component and system manufacturer. The constant development and further development of new and existing competencies has enabled us to become a valuable partner to a wide variety of clients in many sectors of industry.

Gebrüder Dreher Gas Springs are maintenance-free and ready to install. They are available in pressure pipe diameters of 15 mm to 28 mm and forces of 10 N to 2500 N. The gas springs should be fitted with the piston rods pointing downwards, as this guarantees minimum friction and optimum damping performance. The gas spring is a sealed system which is filled with pressurised nitrogen gas. Oil is used for damping. The inward and outward speed is determined by the choke opening on the piston. The large number of connections and built-on components makes fitting easier and means that there are universal applications for the gas spring. Gas springs are used everywhere where things need to be raised and lowered. They support muscular force and enable controlled lifting and lowering of covers, flaps, hoods, etc. The gas springs are produced individually to meet customer specifications and are therefore not available from stock. The lead time for your order will depend on our order book. But we have a reputation for short delivery times and impeccable product quality. Further information is available from our fully trained personnel.

Gebrüder Dreher pneumatic tension springs available on request.

Quality

The quality of our products is a result of our process-oriented quality management program, which implements the company's quality policy in each individual area.

Our quality assurance leadership reports and is subordinate solely to the top company management. Our clear target guidelines ensure our high standard of quality with a comprehensive and universal manufacturing and testing plan as well as seamless monitoring of the entire process by our quality management team.

It is our philosophy to achieve maximum customer satisfaction through the highest quality standards, consistent on-time delivery, high flexibility and reliable customer service. In order to safeguard our achievements for the future, the system is regularly audited by an independent organization.

Since October 15, 2002, our QM System has been certified under **DIN EN ISO 9001:2000**.

You are able to download the **certificate** for our quality assurance system on our web page.

Calculation

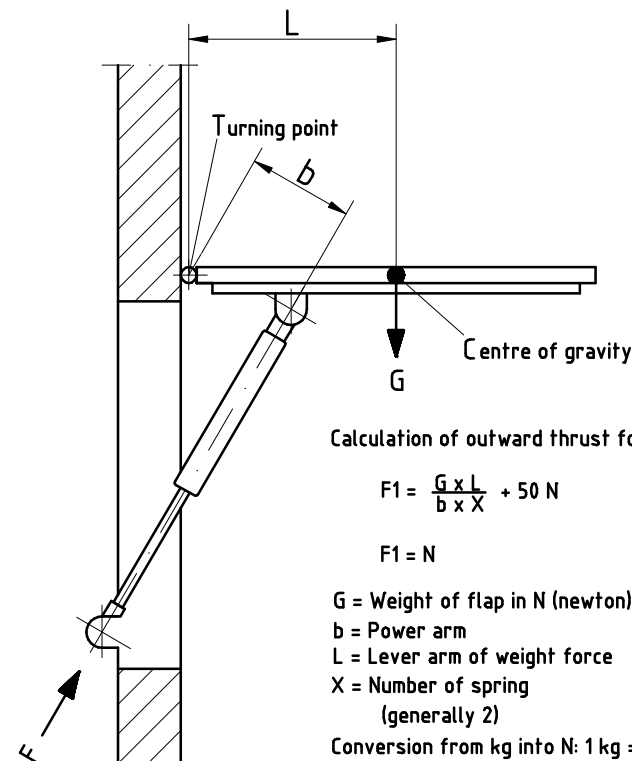

Gas Spring Characteristic Curve in Force-Distance Diagram

- F1 = Outward thrust force when piston rod moved outwards (given in type description)
- F2 = Outward thrust force when piston rod moved inwards
- F3 = Insertion thrust force when piston rod moved outwards
- F4 = Insertion thrust force when piston rod moved inwards
- FR = Friction force

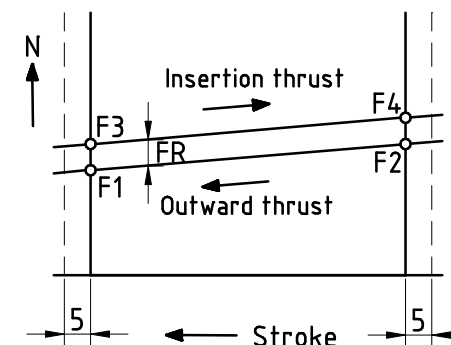

Moving the gas spring inward produces a linear increase in the force (progression) measured starting from the nominal force across the whole stroke (see diagram).

Gas Spring Type 6 - 15

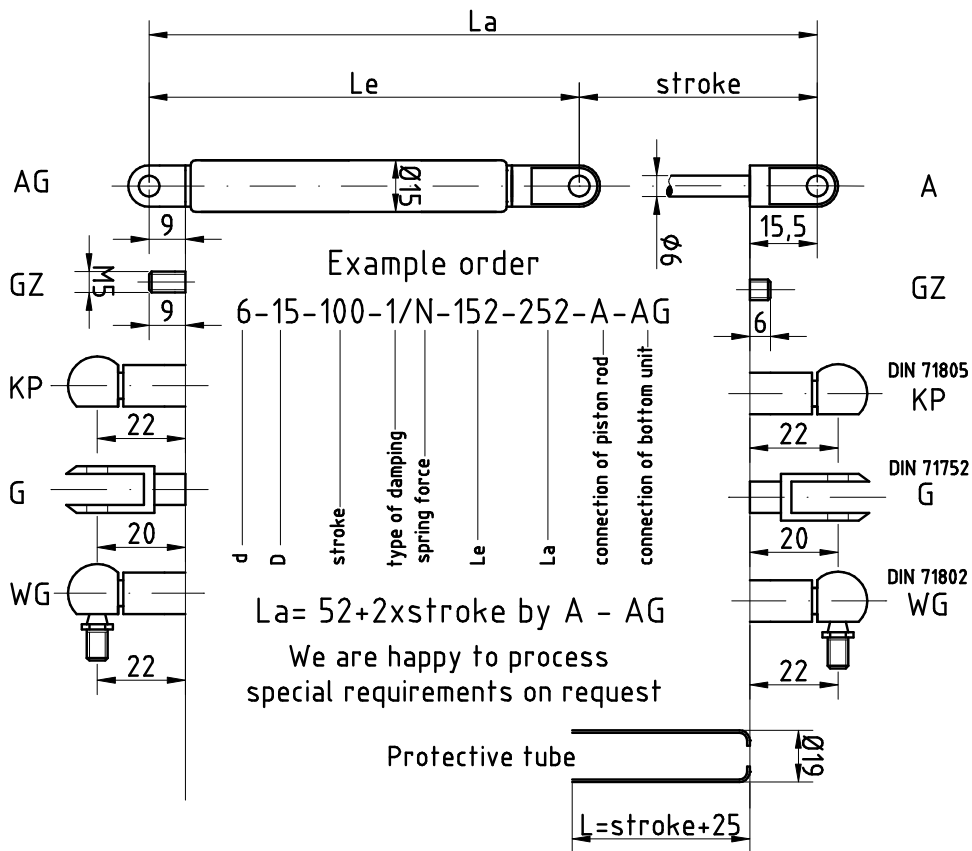

Technical Specifications and Instructions Type 6 - 15

The gas spring is maintenance-free and ready to install
 Final position damping: approx. 10 mm
 On order: longer end position damping, no damping
 Fill medium: Nitrogen oil
 Outward thrust force F_1 at 20°C: 10 N to 400 N

Gas Spring Type 8 - 19

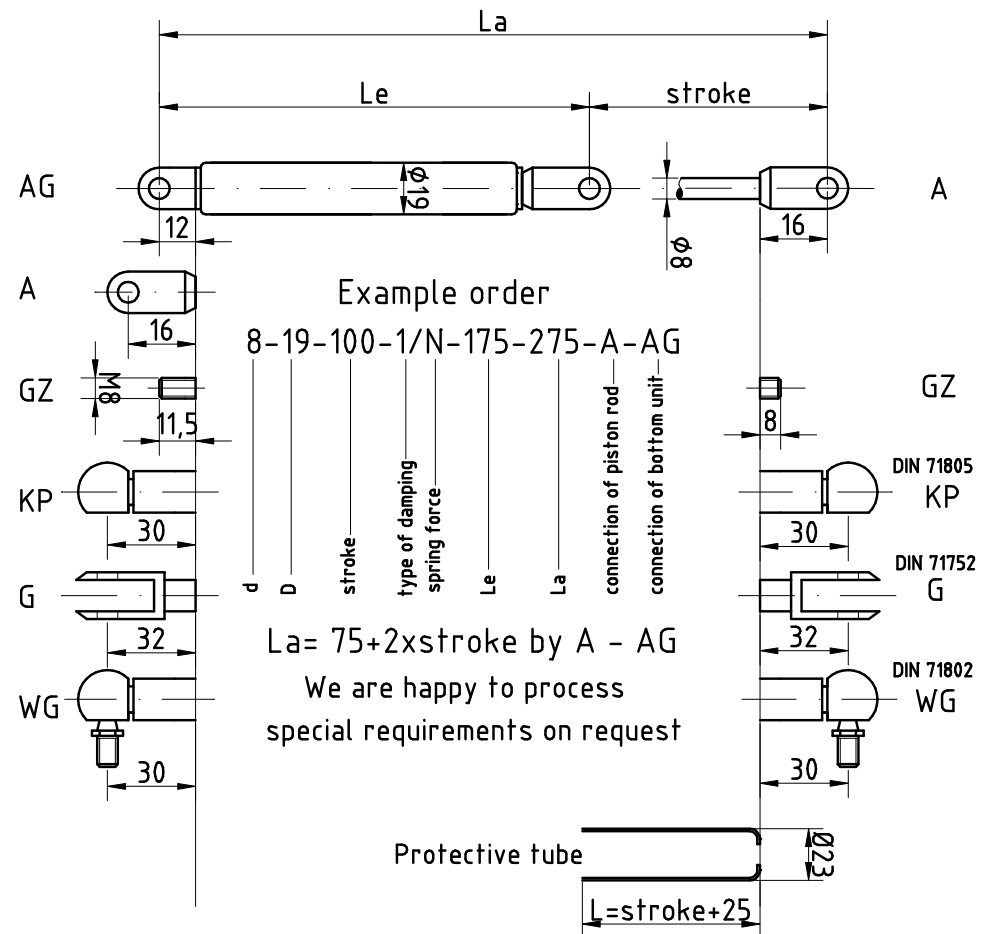

Technical Specifications and Instructions Type 8 - 19

The gas spring is maintenance-free and ready to install
 Final position damping: approx. 10 mm
 On order: longer end position damping, no damping
 Fill medium: Nitrogen oil
 Outward thrust force F_1 at 20°C: 50 N to 700 N
 Special request: piston rod $\phi 8$ mm pressure pipe $\phi 23$ mm

Gas Spring Type 10 - 23

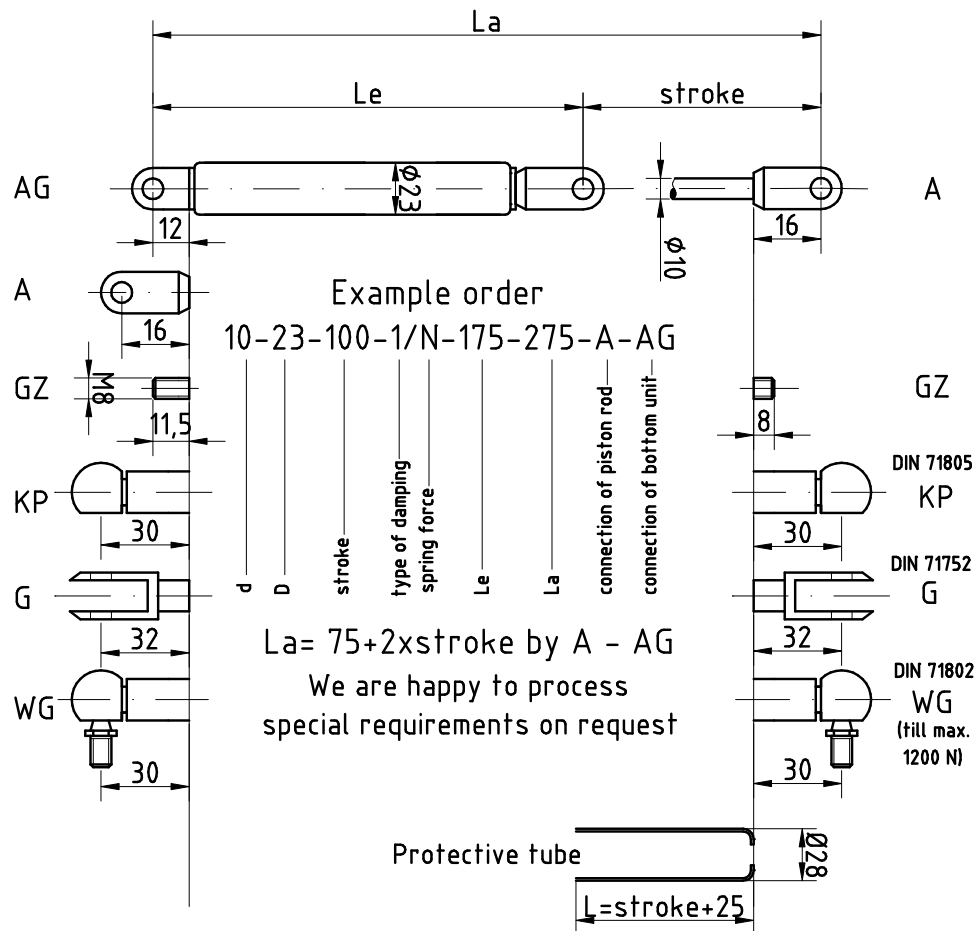

Technical Specifications and Instructions Type 10 - 23

The gas spring is maintenance-free and ready to install
 Final position damping: approx. 10 mm
 On order: longer end position damping, no damping
 Fill medium: Nitrogen oil
 Outward thrust force F1 at 20°C: 80 N to 1200 N
 Special request: piston rod ϕ 10 mm pressure pipe ϕ 28 mm

Gas Spring Type 14 - 28

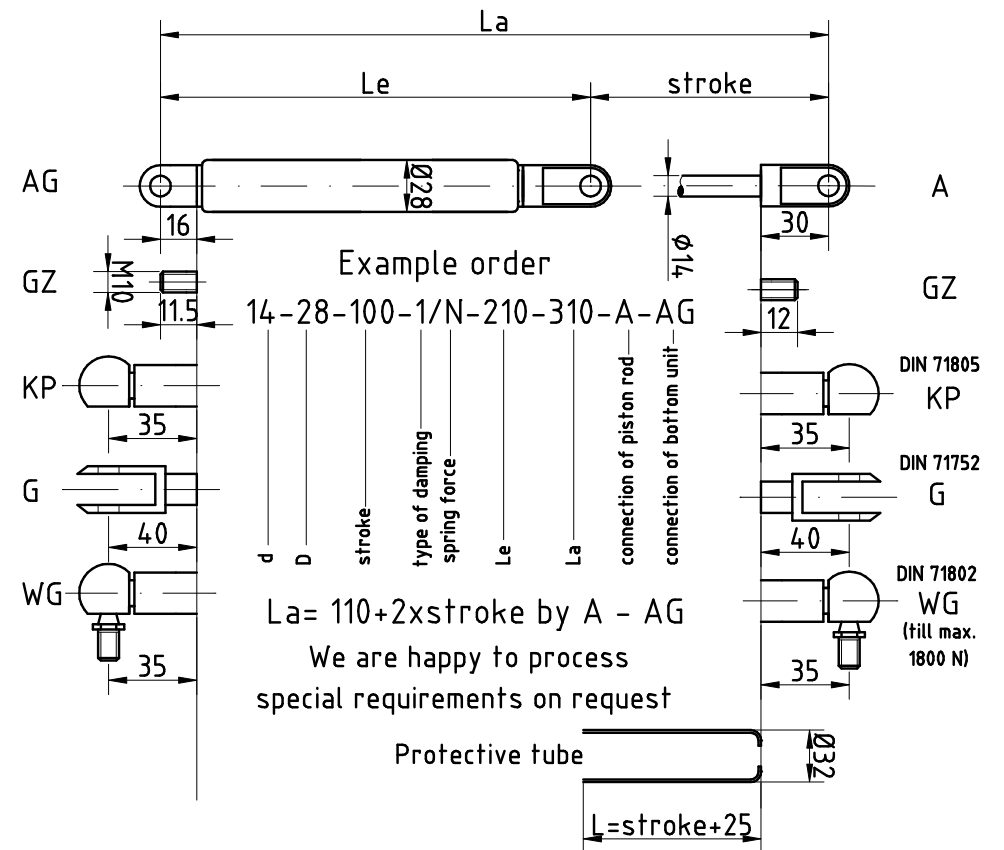

Technical Specifications and Instructions Type 14 - 28

The gas spring is maintenance-free and ready to install
 Final position damping: approx. 10 mm
 On order: longer end position damping, no damping
 Fill medium: Nitrogen oil
 Outward thrust force F1 at 20°C: 100 N to 2500 N

Connections for Gas Spring Type 6 - 15

eye milled / AG

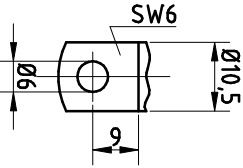

eye / A

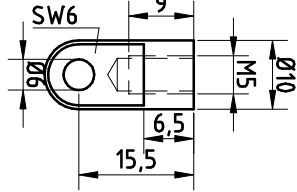

ball socket / KP

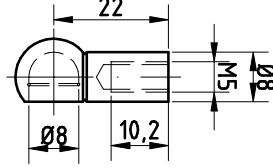

angle joint / WG

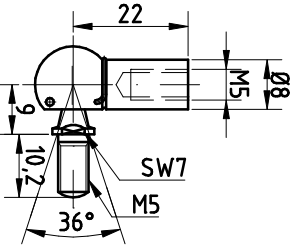

fork / G

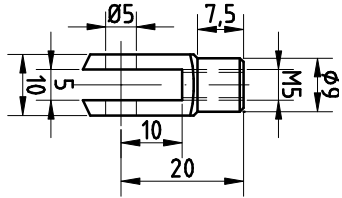

Connections for Gas Spring Type 8 - 19

eye milled / AG

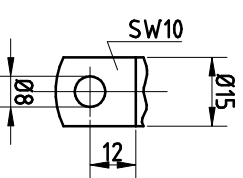

eye / A

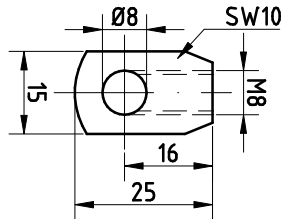

ball socket / KP

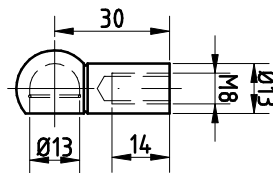

angle joint / WG

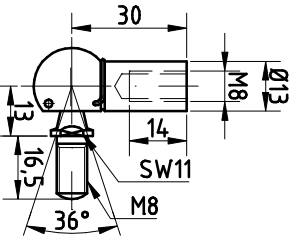

fork / G

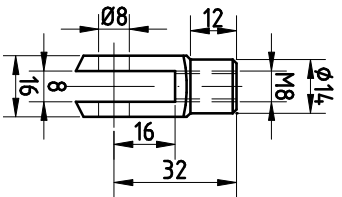

Special connections, fittings and attachment parts available on request.

Connections for Gas Spring Type 10 - 23

eye milled / AG

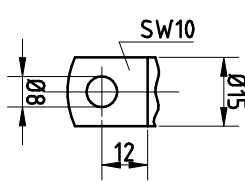

eye / A

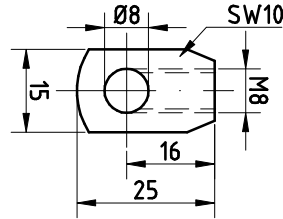

ball socket / KP

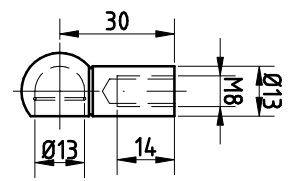

angle joint / WG

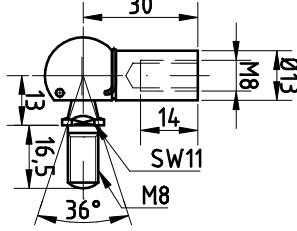

fork / G

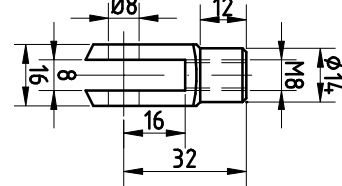

Connections for Gas Spring Type 14 - 28

eye milled / AG

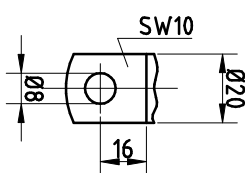

eye / A

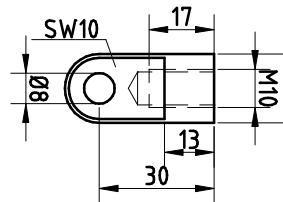

ball socket / KP

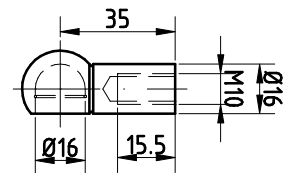

angle joint / WG

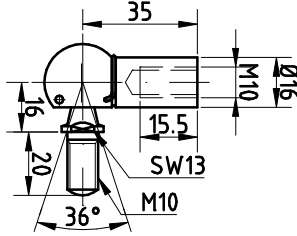

fork / G

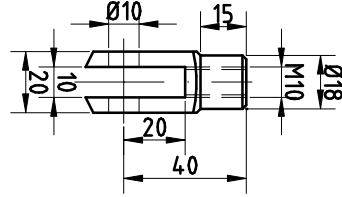

Special connections, fittings and attachment parts available on request.

Damping Types

- 0 Rapid inward and outward speeds, no terminal damping
- 1 Rapid inward and outward speeds, normal terminal damping
- 2 Braking on inward motion
- 3 Braking on inward and outward motion of piston rod

Outward and Inward Speed

You can determine the outward or inward speed of the spring by selecting the size of the brake nozzle hole through the piston correspondingly high or low.

Storage and Carriage of Products

If stored dry with the piston rods pointing downwards, the gas springs should not lose pressure. They should not be stored for longer than 12 month and be operated (inward and outward motion of the piston rod) at least once after a storage time of 6 up to maximum 12 month. When the products are first used after an extended period of disuse, a slip-stick effect can occur, which means increased force is required to move the piston rod in and out. To prevent damage, gas springs should not be transported as bulk goods. Impurities must be avoided, including in particular those due to thin packing films or adhesive tapes.

Installation of Gas Springs

The gas springs should be fitted with the piston rods pointing downwards, as this guarantees minimum friction and optimum damping performance. Horizontal installation should be avoided. If the connections to the piston rod and tube must be aligned with one another, the piston rod and tube may only be turned to the right (clockwise).

The installation / removal of gas springs must always occur in unloaded condition.

Provide play in linkage points, i.e. avoid rigid installation. Lubricate linkage points if necessary, in order to reduce friction and increase the service life of the connections.

Avoid chocking the piston rods (for gas springs with long strokes, the product must have additional bearing / guidance. Sagging, bending and buckling must be avoided). Only axial strain is allowed (risk of buckling). There must be no transverse or torsional forces.

Gas springs may be used as end stops if the nominal force (see label on each gas spring) does not exceed +30% (no overexpansion or compression of the products), i.e. the products can only be subjected to pressure or torsion at their nominal force +30%. Especially where there are strong forces, mechanical stops should be put into place as well in order to prevent compression or over-extension of the product.

General Information

Gas springs are not safety components!

If gas springs are used in places where product failure could lead to personal injury and/or damage to property, additional safety elements need to be fitted!

Gas springs are subject to wear and need to be replaced as a function of the strain on them and the application they are used for. It is especially important to protect them from corrosion in order to increase their service life.

Gas springs can be used in ambient temperatures from -30° C to +100° C. Special seal sets are available for other temperature ranges (-20° C to +200° C). Do not overheat gas springs or expose to naked flames.

Warning: Maximum stroke speed = 300 mm/s when installed.

High stroke speeds and/or stroke frequencies can lead to overheating and thus to damage to the seals and failure of the product. High stroke speeds or accelerations must not put excessive strain on the product.

Gas springs are filled with pure nitrogen. Nitrogen is an inert gas, which does not combust, does not explode and is not toxic. Note: Gas springs have very high internal pressure (up to approx. 160 bar). They must never be opened without instructions. Our opening and disposal instructions are available for download on our website under the menu item Downloads.

Minor damage, corrosion or paint residues on the piston rod will cause the spring to fail (seals are damaged). The cylinder pipe must not be damaged or misshapen! Any modifications to the product made by third parties will invalidate the guarantee.

Important: The adhesive labels must not be removed from the gas springs; no liability can be accepted for damage caused by the removal of the labels or resulting from disregarding the warnings and instructions on the labels.

Disposal

When gas springs are no longer needed, they should be disposed of in an environmentally friendly manner. In particular, the compressed nitrogen gas and the oil should be discharged and disposed of by qualified experts. Our opening and disposal instructions are available for download on our website under the menu item Downloads.

Gebrüder Dreher Drehteile & Gasfedern GmbH

Winkelstraße 4

78592 Egesheim

Germany

Phone: +49 [0] 7429 / 93 11-0

Fax: +49 [0] 7429 / 20 90

E-Mail: info@gebrueder-dreher.de

Internet: www.gebrueder-dreher.de